

straightcurve®

# Specifications

## 400mm Fixed height planter box

PANEL LENGTHS 400mm, 600mm, 800mm, 1000mm, 1200mm

TOP THICKNESS 46mm



Steel plate thickness 2mm

### FINISHES

- Galvanised Steel
- Weathering Steel

### ADDITIONAL ACCESSORIES

- ✔ Straight Join Set (12 x Tek Screws 12G x 16mm)
- ✔ Closed Corner Set (6 x Tek Screws 12G x 16mm)
- ✔ Open Corner Set (8 x Tek Screws 12G x 16mm)
- ✔ Standard crossover Bracing Set
- ✔ Bracing Set
- ✔ Large Anchor Set (6 x Tek Screws 12G x 16mm)

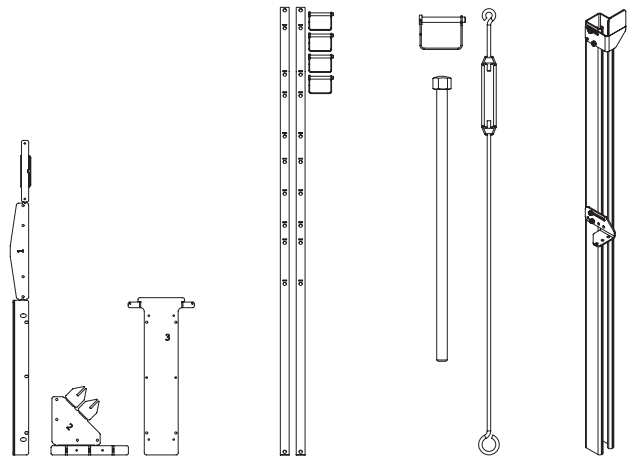

# Installation guide

## 400mm Fixed height planter box

Scan me for Video installation!



Scan the code or follow the link below for installation video.  
400mm Fixed height planter box installation video

### PREPARATIONS

Check you have the right panel sizes and join pieces (1,2 or 3) needed to achieve your goal. When building the planter box, do so on a flat work surface. Create a level installation base for set up.

### TIP

- ✔ You may have several panel combinations that can make the same size bed so consider what combo will give the neatest seam arrangement where opposing straight joins align.

### BRACING

Bracing is required wherever straight joins occur. For standard width beds (1200mm or less) use the standard crossover bracing set. For wide beds (>1200mm) use bracing sets or large anchor post, depending on conditions.

### CROSSOVER BRACING INSTALLATION

1. Brake off brace to correct length
2. Fix brace between the top of one join and the bottom of the opposing join through the oval holes with bolts supplied.

### JOINING /CORNER OPTIONS

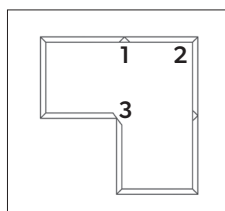

The three types of joining options include:

1. Straight join
2. Closed corner
3. Open corner

## 1. STRAIGHT JOIN

### A. BRING 2 PANELS TOGETHER

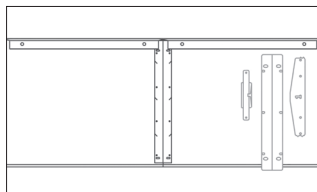

### B. FIX IN TOP JOINER

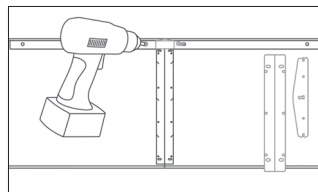

### C. FIX IN BOTTOM JOINER

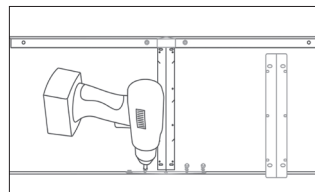

### D. FIX IN CENTRAL JOINER

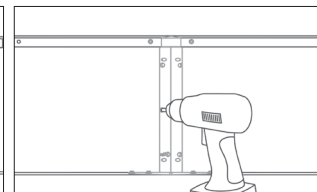

## 2. CLOSED CORNER

### A. BEND TOP JOINER TO SHAPE

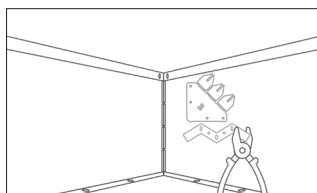

### B. FIX IN TOP JOINER

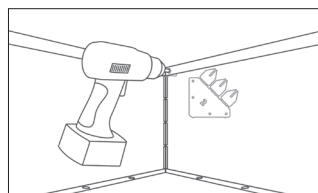

### C. FIX IN BOTTOM JOINER

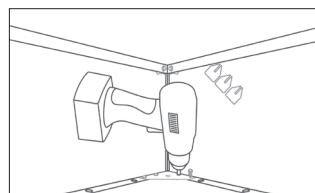

### D. HAMMER IN CENTRAL TABS

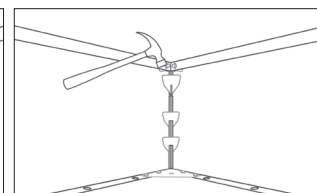

# Installation guide

## 400mm Fixed height planter box

*Scan me for Video installation!*



Scan the code or follow the link below for installation video.  
400mm Fixed height planter box installation video

### 3. OPEN CORNER

A. BRING 2 PANELS TOGETHER

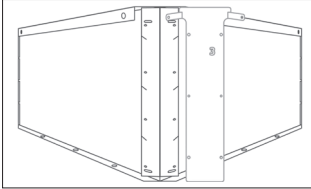

B. FIX IN JOINER AT TOP

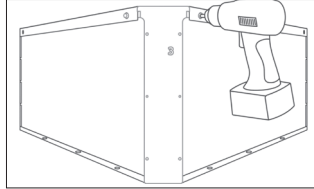

C. FIX ALONG THE SPINE

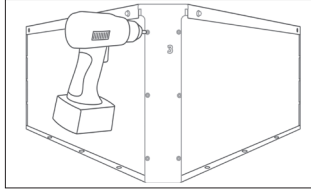

### USE BRACING STRAPS OR BRACING SYSTEM OPTIONS

